

# E3S-DB

## Outstanding detection performance for all kinds of transparent objects





- Most reliable detection of all transparent objects such as PET bottles, glass bottles or transparent trays
- SmartTeach for fast set up and optimum threshold setting
- Sensing distance up to 4.5 m
- Narrow beam types with 2 mm spot detecting smallest gaps
- Proven for environments in Food & Beverage industry

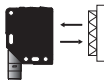

## Ordering Information

### Sensors

 Red light





Sensor type	Sensitivity adjustment	Connection method	Sensing distance, typ.	Model	
				NPN output	PNP output
Retro-reflective with MSR function 	SmartTeach	Pre-wired (2 m)	 0 to 4.5 m with E39-R8	E3S-DBN11 2M	E3S-DBP11 2M
		Connector (M12, 4 pins)		E3S-DBN21	E3S-DBP21
		Pigtail Connector* <sup>1</sup> (M12, 4 pins)		E3S-DBN31	E3S-DBP31
		Pre-wired (2 m)	Narrow beam  0 to 0.7 m with E39-R21	E3S-DBN12 2M	E3S-DBP12 2M
		Connector (M12, 4 pins)		E3S-DBN22	E3S-DBP22
		Pigtail Connector* <sup>1</sup> (M12, 4 pins)		E3S-DBN32	E3S-DBP32
	Trimmer (11 turns)	Pre-wired (2 m)	 0 to 4.5 m with E39-R8	E3S-DBN11T 2M	E3S-DBP11T 2M
		Connector (M12, 4 pins)		E3S-DBN21T	E3S-DBP21T
		Pigtail Connector* <sup>1</sup> (M12, 4 pins)		E3S-DBN31T	E3S-DBP31T
		Pre-wired (2 m)	Narrow beam  0 to 0.7 m with E39-R21	E3S-DBN12T 2M	E3S-DBP12T 2M
		Connector (M12, 4 pins)		E3S-DBN22T	E3S-DBP22T
		Pigtail Connector* <sup>1</sup> (M12, 4 pins)		E3S-DBN32T	E3S-DBP32T

\*<sup>1</sup> OMRON SmartClick connector for fast and save connection.

# E3S-DB

## Reflectors [Refer to Dimensions on page 9.]



Reflectors required for Retro-reflective Sensors: A Reflector is not provided with the Sensor. Be sure to order a Reflector separately.

Sensor	Sensing distance, typ.	Appearance	Dimensions [mm]	Remarks	Model
E3S-DB__1(T)	0 to 4.5 m		100 × 100		E39-R8
	0 to 3.5 m		60 × 40		E39-R1S
	0 to 3 m		60 × 40	Special polarizing filter for enhanced PET detection	E39-RP1
E3S-DB__2(T)	0 to 700 mm		35 × 30	For narrow gap detection	E39-R21
	0 to 700mm		60 × 20		E39-R52

Note: For more reflectors please check OMRON catalogue or contact your OMRON representative.

## Mounting brackets [Refer to Dimensions on page 9.]

A Mounting Bracket is not enclosed with the Sensor. Order a Mounting Bracket separately if required.

Appearance	Material	Remarks	Model
	SUS304	A Mounting bracket is not provided with the Sensor.	E39-L192
	SUS304	A Mounting bracket is not provided with the Sensor.	E39-L193

## Sensor I/O connectors

Size	Specifications	Appearance	Cable type	Model
M12 (4 pins)	Standard PVC	Straight	2 m	XS2F-M12PVC4S2M-EU
			5 m	XS2F-M12PVC4S5M-EU
		Angled	2 m	XS2F-M12PVC4A2M-EU
			5 m	XS2F-M12PVC4A5M-EU
	Smartclick PVC	Straight	2 m	XS5F-D421-D80-F
			Smartclick 5 m	XS5F-D421-G80-F

## Ratings and Specifications

Sensing method		Retro-reflective with MSR function			
Model	NPN output	E3S-DBN_1	E3S-DBN_1T	E3S-DBN_2	E3S-DBN_2T
Item	PNP output	E3S-DBP_1	E3S-DBP_1T	E3S-DBP_2	E3S-DBP_2T
Sensing distance, typ. <sup>1</sup>		0 to 4.5 m (with E39-R8)		0 to 700 mm (with E39-R21)	
Sensing distance, recommended <sup>2</sup>		0 to 3.5 m (with E39-R8)		0 to 500 mm (with E39-R21)	
Light source (wavelength)		Red LED (624 nm)			
Power supply voltage		10 to 30 VDC, including 10% ripple (p-p)			
Current consumption		720 mW max. (24 VDC, 30 mA)			
Control output		Load power supply voltage: 30 VDC max., Load current: 100 mA max. (Residual voltage: 2 V max.) NPN/PNP transistor output (depending on model)			
Operating modes		OUT1: L-ON/OUT2: D-ON (antivalent output)			
Protection circuits		Reversed power supply polarity protection, Output short-circuit protection, Reversed output polarity protection, Missconnection protection, Mutual interference suppression			
Response time		0.5 ms			
Sensitivity adjustment		SmartTeach	11-turn trimmer	SmartTeach	11-turn trimmer
Auto-Compensation function (AC3)		yes (default = OFF)	–	yes (default = OFF)	–
Lock function		yes	–	yes	–
Ambient illumination		Incandescent lamp: 3,000 lx max./Sunlight: 10,000 lx max.			
Ambient temperature range		Operating: –25 to 60°C/Storage: –40 to 70°C (with no icing or condensation)			
Ambient humidity range		Operating: 35 to 85% RH/Storage: 35 to 95% RH (with no condensation)			
Insulation resistance		20 MΩ min. at 500 VDC			
Dielectric strength		1,000 VAC at 50/60Hz for 1 min. Between current-carrying parts and case			
Vibration resistance		Destruction: 10 to 55 Hz, 1.5 mm double amplitude for 2 hours each in X,Y,Z directions			
Shock resistance		Destruction: 500 m/s <sup>2</sup> , 3 times each in X,Y,Z directions			
Degree of protection		IEC: IP67, DIN 40050-9: IP69K			
Connection method		Pre-wired cable (standard length: 2 m) or M12 4-pin connector or Pigtail (0.3 m/M12 4-pin)			
Indicators		Light indicator (orange), Stability indicator (green)			
Weight (packed state)		Approx. 40 g			
Materials	Housing	PBT/ABS			
	Lens & indicators	PMMA (Polymethylmethacrylate)			
	Buttons	Elastomer			
	Cable	PVC			
Accessories		Instruction manual			

<sup>1</sup> Maximum sensing distance for typical reflector and sensor

<sup>2</sup> Operating sensing distance recommended for factory environments

# E3S-DB

## Engineering Data (Reference Value)

### Parallel Operating Range

#### E3S-DB□□1(T)

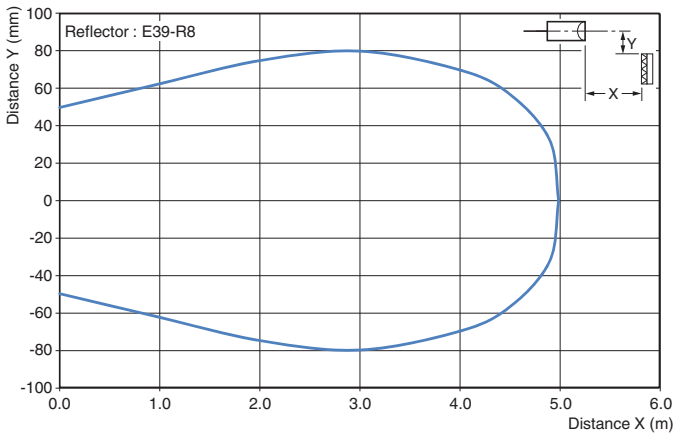

#### E3S-DB□□2(T)

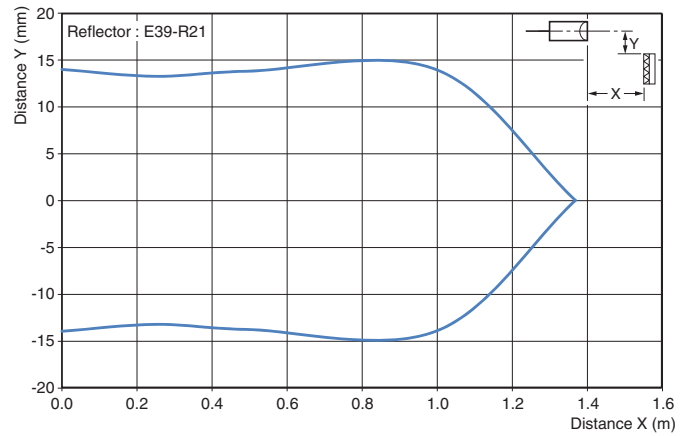

### Excess Gain vs. Distance

#### E3S-DB□□1(T)

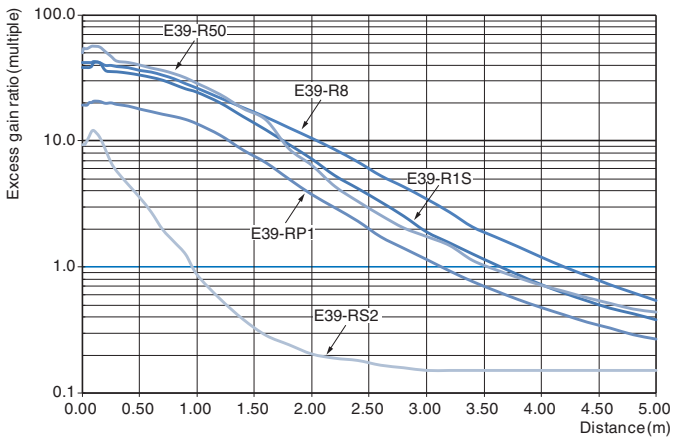

#### E3S-DB□□2(T)

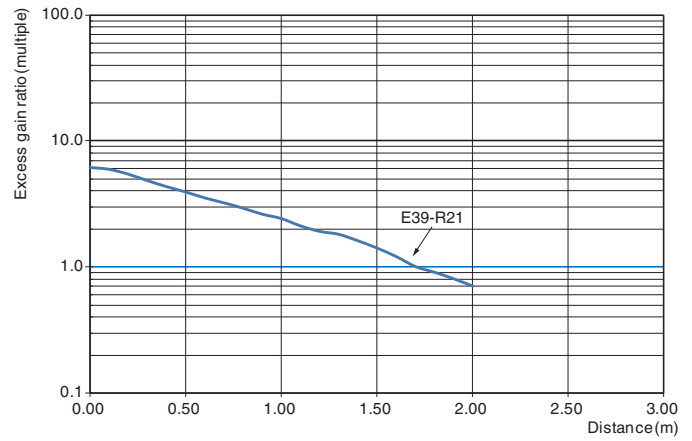

### Spot size vs. Distance

#### E3S-DB□□1(T)

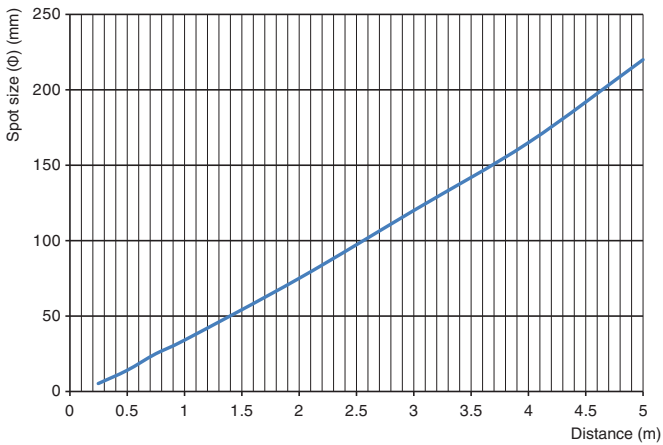

#### E3S-DB□□2(T)

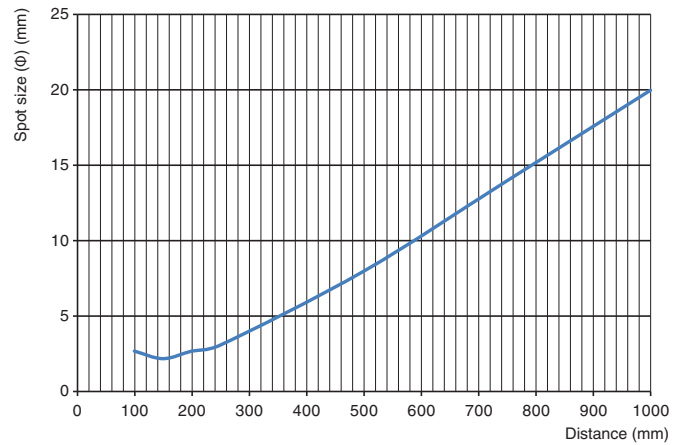

Attenuation level vs. Sensing Object Characteristics (typical values)

E3S-DB□□1(T)

With standard reflector, e.g. E39-R1S or E39-R8

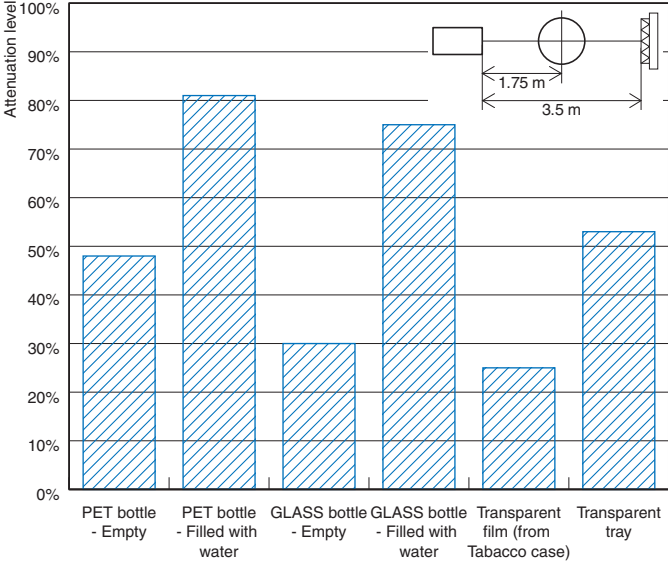

With p-opaquiring reflector E39-RP1

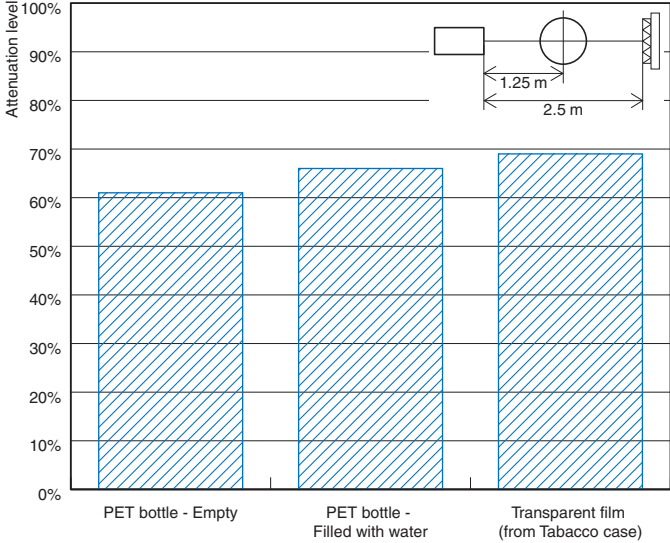

E3S-DB□□2(T)

With reflector E39-R21

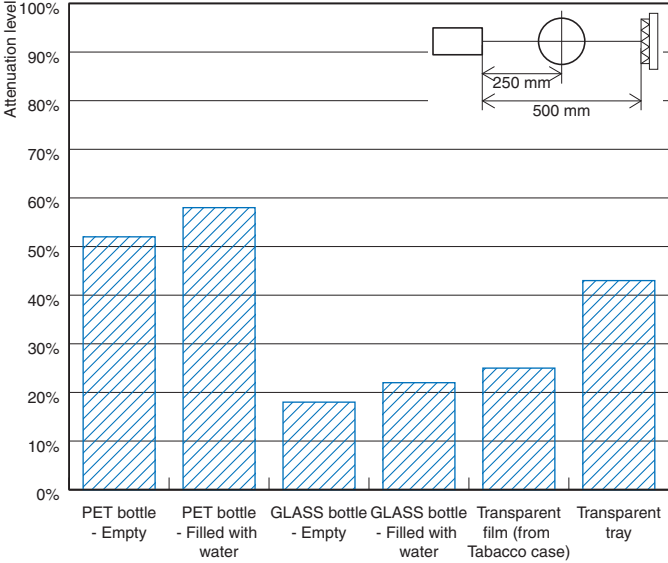

# E3S-DB

## Output circuit diagram

### NPN Output

Model	Timing charts		Output circuit
	Output 1 (pin 4)	Output 2 (pin 2)	
E3S-DBN__			

### PNP Output

Model	Timing charts		Output circuit
	Output 1 (pin 4)	Output 2 (pin 2)	
E3S-DBP__			

### Connector Pin Arrangement

#### M12 Connector Pin Arrangement



### Connectors (Sensor I/O connectors)

#### M12 4-wire Connectors

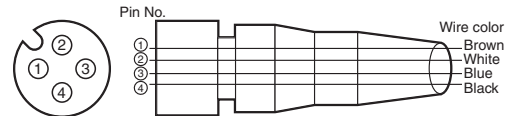

Classification	Wire color	Connector pin No.	Application
DC	Brown	①	Power supply (+V)
	White	②	Output2 (Dark ON)
	Blue	③	Power supply (0 V)
	Black	④	Output1 (Light ON)

## Operation

### Adjusting Trimmer type (11-turn)

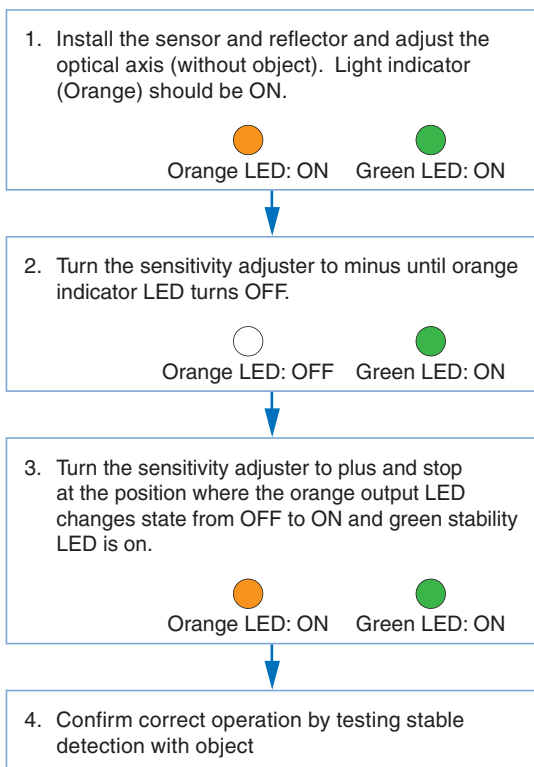

Note: For opaque object set the sensitivity adjuster to maximum.

### Adjusting SmartTeach type

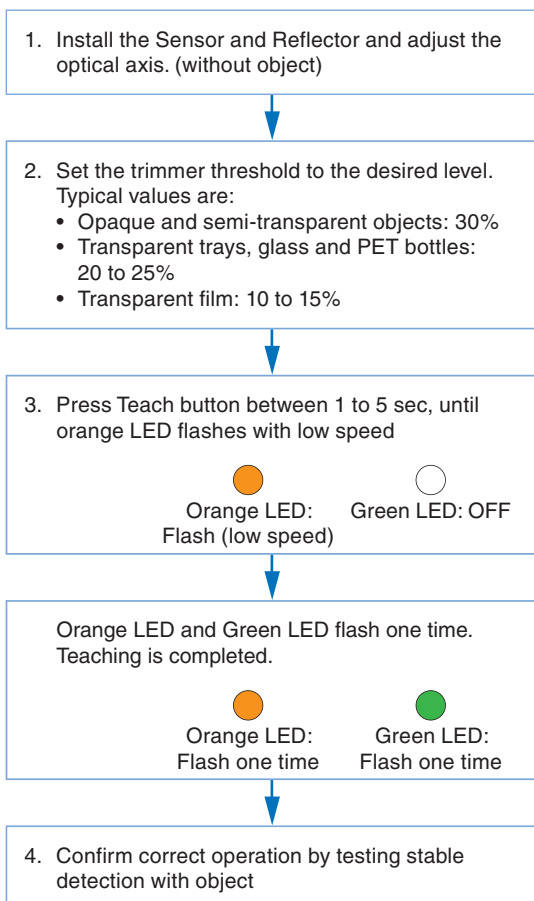

### Activation/ Deactivation of Lock function (SmartTeach only)

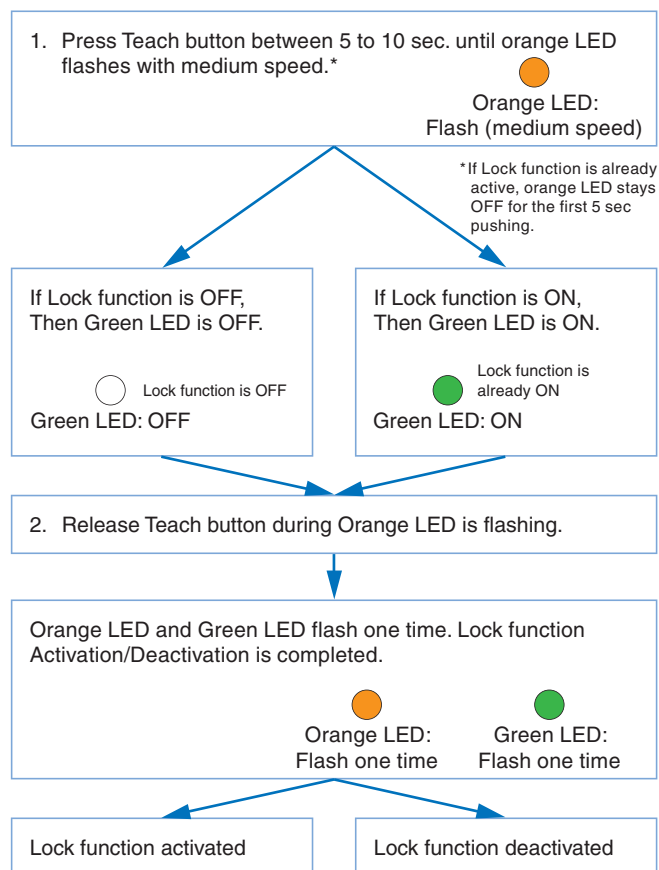

### Activation/Deactivation of AC3 Auto compensation function (SmartTeach only)

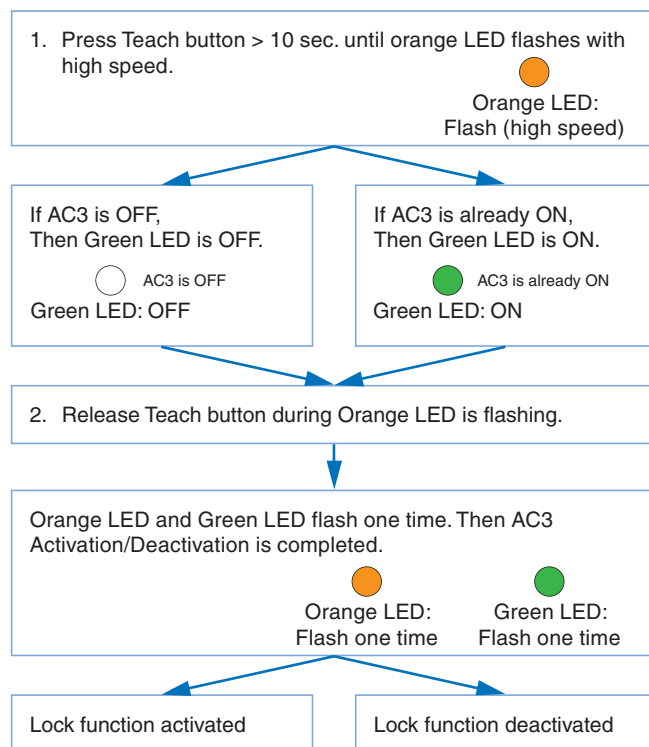

Note:  
 • Default value of AC3 is OFF.  
 • If Lock function is activated, please deactivate Lock function first

# E3S-DB

## Safety Precautions

Refer to *Warranty and Limitations of Liability*.

### WARNING

This product is not designed or rated for directly or indirectly ensuring safety of persons. Do not use it for such a purpose.



### CAUTION

Never use the product with an AC power supply.  
Do not use the product with voltage in excess of the rated voltage.



Do not use the product with incorrect wiring.  
Otherwise, explosion, fire, malfunction may result.



### Precautions for Safe Use

Be sure to follow the safety precautions below for added safety.

1. Do not use the sensor under the environment with explosive, flammable or corrosive gas.
2. Do not use the sensor under the oil or chemical environment.
3. Do not use the sensor in the water, rain or outdoors.
4. Do not use the sensor under the environment under the other conditions in excess of rated.
5. Do not use the sensor in place that is exposed by direct sunlight.
6. Do not use the sensor in place where the sensor may receive direct vibration or shock.
7. Do not use the thinner, alcohol, or other organic solvents.
8. Never disassemble, repair nor tamper with the sensor.
9. Please process it as industrial waste.
10. Do not use the high concentration cleaning agent because it might cause the trouble. Avoid the jet of high-pressure water over

the rated values because it might deteriorate the degree of protection.

11. Perform sensitivity adjustment with the torque of 0.06 N·m or less.
12. Do not exert excessive force on the connector section.
13. This product cannot be used as a detection system to protect human body.
14. These sensors are certificated by the UL standard on the assumption of usage in class 2 circuit. Please use it with “Class 2 power supply” in the United States or Canada. The accessory cable assembly, Recognized XS2F-D4 Series and/or Recognized XS2W-D4 Series by Omron shall be used. Cables that have wires less than 24 AWG (0.2 mm<sup>2</sup>) are for connection to terminal blocks and are not for field splicing. External overcurrent protection of 1 A for 26 AWG, 2 A for 24 AWG, or 3 A for 22 AWG wire shall be provided for cable protection.
15. Output pulses may be generated when the power supply is turned off or turned on within short period after turning off the power supply, so be sure to turn off power supplies of other devices or loads first.

### Precautions for Correct Use

Be sure to follow the safety precautions below for added safety

1. Laying Sensor wiring in the same conduit or duct as high-voltage wires or power lines may result in malfunction or damage due to conduit or use shielded cable.
2. If a commercial switching regulator is used, ground the FG (frame ground) terminal.
3. The sensor will be available 100 ms after the power supply is tuned ON. Start to use the sensor 100 ms or more after turning ON the power supply. If the load and the sensor are connected to separate power supplies, be sure to turn ON the sensor first.
4. Output pulses may be generated even when the power supply is OFF. Therefore, it is recommended to first turn OFF the power supply for the load or the load line.



Dimensions

Tolerance class IT16 applies to dimensions in this data sheet unless otherwise specified.

Sensors

E3S-DB

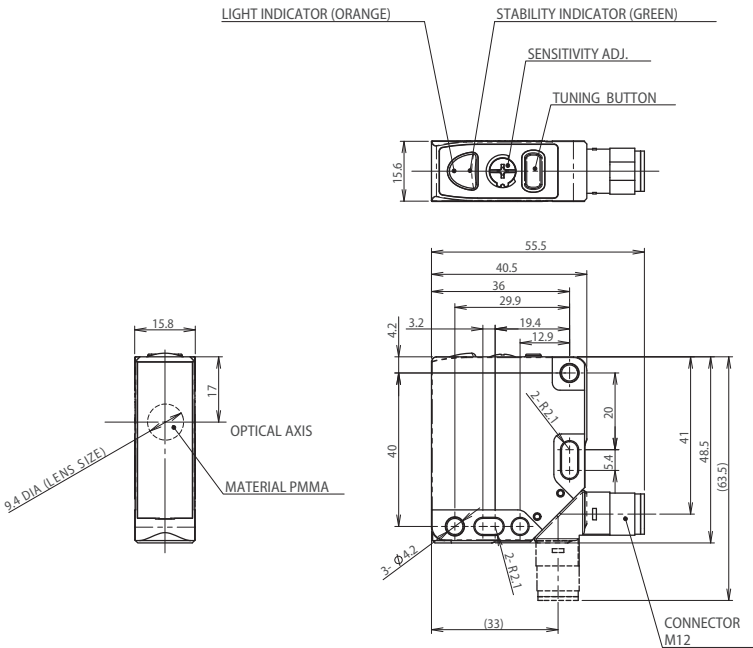

NOTE  
1.REFER BELOW FOR PIN'S CONFIGURATION.

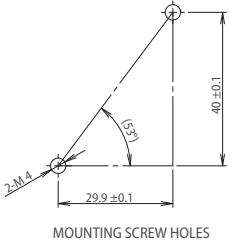
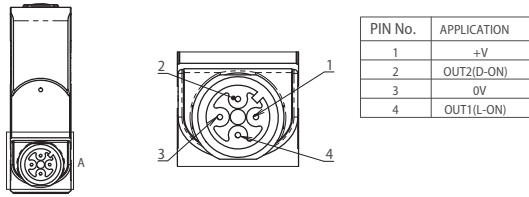

E3S-DB (T)

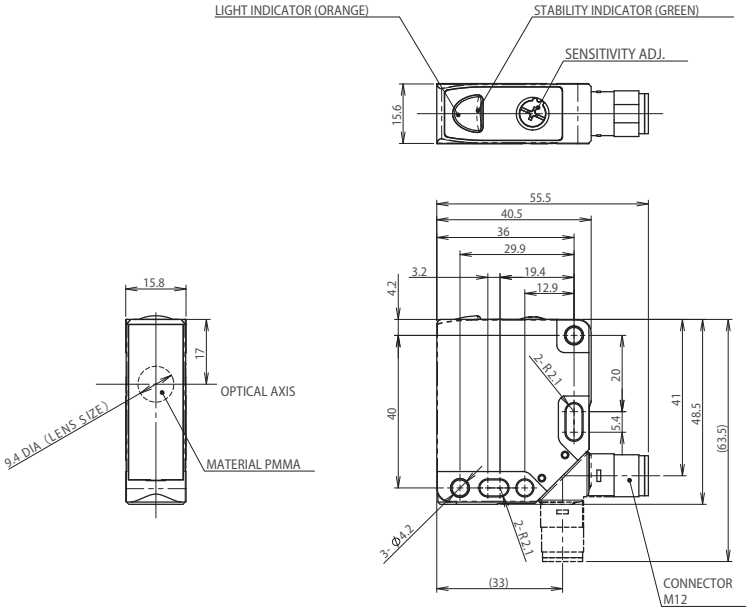

NOTE  
1.REFER BELOW FOR PIN'S CONFIGURATION.

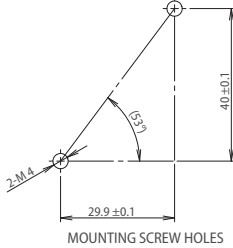
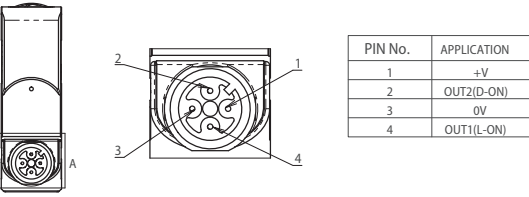

# E3S-DB

## Accessories (Order Separately)

### Reflector

#### E39-R8

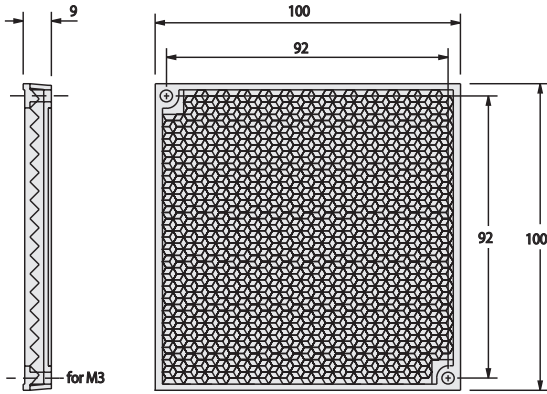

#### E39-R21

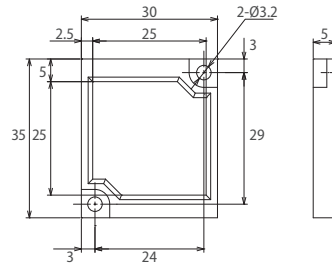

#### E39-R52

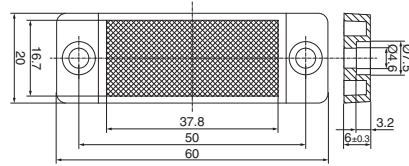

### Mounting bracket

#### E39-L192

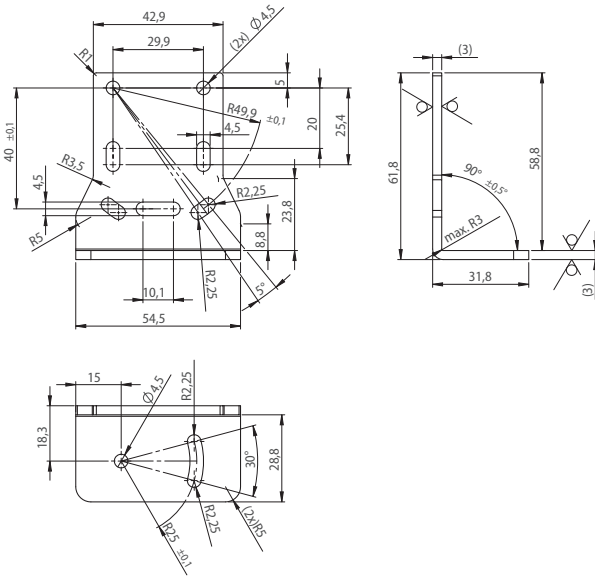

#### E39-L193

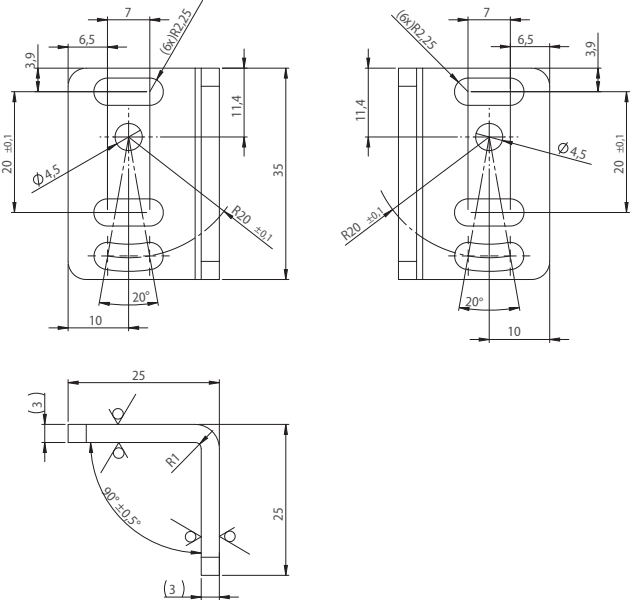

ALL DIMENSIONS SHOWN ARE IN MILLIMETERS.

To convert millimeters into inches, multiply by 0.03937. To convert grams into ounces, multiply by 0.03527.



# Terms and Conditions Agreement

## Read and understand this catalog.

Please read and understand this catalog before purchasing the products. Please consult your OMRON representative if you have any questions or comments.

## Warranties.

(a) Exclusive Warranty. Omron's exclusive warranty is that the Products will be free from defects in materials and workmanship for a period of twelve months from the date of sale by Omron (or such other period expressed in writing by Omron). Omron disclaims all other warranties, express or implied.

(b) Limitations. OMRON MAKES NO WARRANTY OR REPRESENTATION, EXPRESS OR IMPLIED, ABOUT NON-INFRINGEMENT, MERCHANTABILITY OR FITNESS FOR A PARTICULAR PURPOSE OF THE PRODUCTS. BUYER ACKNOWLEDGES THAT IT ALONE HAS DETERMINED THAT THE PRODUCTS WILL SUITABLY MEET THE REQUIREMENTS OF THEIR INTENDED USE.

Omron further disclaims all warranties and responsibility of any type for claims or expenses based on infringement by the Products or otherwise of any intellectual property right. (c) Buyer Remedy. Omron's sole obligation hereunder shall be, at Omron's election, to (i) replace (in the form originally shipped with Buyer responsible for labor charges for removal or replacement thereof) the non-complying Product, (ii) repair the non-complying Product, or (iii) repay or credit Buyer an amount equal to the purchase price of the non-complying Product; provided that in no event shall Omron be responsible for warranty, repair, indemnity or any other claims or expenses regarding the Products unless Omron's analysis confirms that the Products were properly handled, stored, installed and maintained and not subject to contamination, abuse, misuse or inappropriate modification. Return of any Products by Buyer must be approved in writing by Omron before shipment. Omron Companies shall not be liable for the suitability or unsuitability or the results from the use of Products in combination with any electrical or electronic components, circuits, system assemblies or any other materials or substances or environments. Any advice, recommendations or information given orally or in writing, are not to be construed as an amendment or addition to the above warranty.

See <http://www.omron.com/global/> or contact your Omron representative for published information.

## Limitation on Liability; Etc.

OMRON COMPANIES SHALL NOT BE LIABLE FOR SPECIAL, INDIRECT, INCIDENTAL, OR CONSEQUENTIAL DAMAGES, LOSS OF PROFITS OR PRODUCTION OR COMMERCIAL LOSS IN ANY WAY CONNECTED WITH THE PRODUCTS, WHETHER SUCH CLAIM IS BASED IN CONTRACT, WARRANTY, NEGLIGENCE OR STRICT LIABILITY.

Further, in no event shall liability of Omron Companies exceed the individual price of the Product on which liability is asserted.

## Suitability of Use.

Omron Companies shall not be responsible for conformity with any standards, codes or regulations which apply to the combination of the Product in the Buyer's application or use of the Product. At Buyer's request, Omron will provide applicable third party certification documents identifying ratings and limitations of use which apply to the Product. This information by itself is not sufficient for a complete determination of the suitability of the Product in combination with the end product, machine, system, or other application or use. Buyer shall be solely responsible for determining appropriateness of the particular Product with respect to Buyer's application, product or system. Buyer shall take application responsibility in all cases.

NEVER USE THE PRODUCT FOR AN APPLICATION INVOLVING SERIOUS RISK TO LIFE OR PROPERTY OR IN LARGE QUANTITIES WITHOUT ENSURING THAT THE SYSTEM AS A WHOLE HAS BEEN DESIGNED TO ADDRESS THE RISKS, AND THAT THE OMRON PRODUCT(S) IS PROPERLY RATED AND INSTALLED FOR THE INTENDED USE WITHIN THE OVERALL EQUIPMENT OR SYSTEM.

## Programmable Products.

Omron Companies shall not be responsible for the user's programming of a programmable Product, or any consequence thereof.

## Performance Data.

Data presented in Omron Company websites, catalogs and other materials is provided as a guide for the user in determining suitability and does not constitute a warranty. It may represent the result of Omron's test conditions, and the user must correlate it to actual application requirements. Actual performance is subject to the Omron's Warranty and Limitations of Liability.

## Change in Specifications.

Product specifications and accessories may be changed at any time based on improvements and other reasons. It is our practice to change part numbers when published ratings or features are changed, or when significant construction changes are made. However, some specifications of the Product may be changed without any notice. When in doubt, special part numbers may be assigned to fix or establish key specifications for your application. Please consult with your Omron's representative at any time to confirm actual specifications of purchased Product.

## Errors and Omissions.

Information presented by Omron Companies has been checked and is believed to be accurate; however, no responsibility is assumed for clerical, typographical or proofreading errors or omissions.